

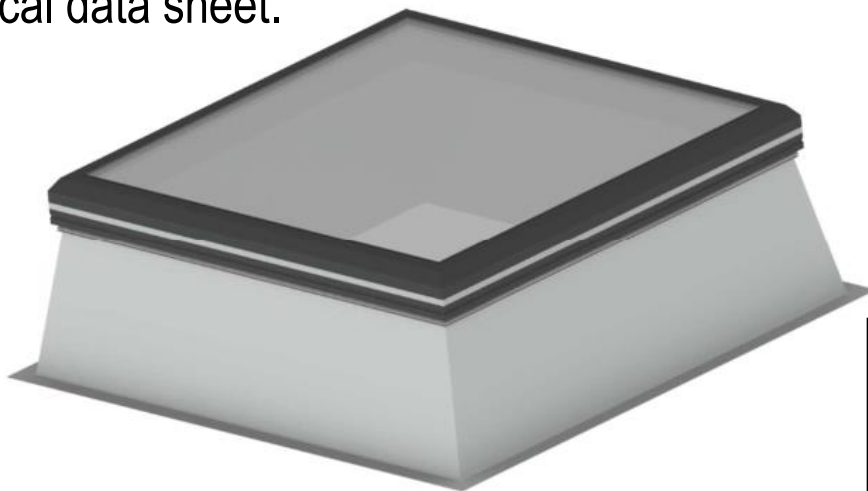

# LAMILUX Glass Skylight FE Passivhaus.

Technical data sheet.



Maximum roof pitch inclination: 25°  
We recommend installation with a 5° inclined upstand when installing on a flat roof to prevent water ponding on the glass.

The Glass Skylight FE Passivhaus has been certified as a Passivhaus component by the Passive House Institute in Darmstadt, Germany. This skylight therefore meets the criteria for one of the most sustainable trends in contemporary construction and is suitable for the most demanding type of energy-efficient construction. The Passive House efficiency classes take into account heat loss and solar energy gain. Minimum heat loss is achieved due to the frame system design, which has excellent U values and low glass edge  $\Psi$ -values. In addition, the narrow frame profiles maximise solar gain.

## Materials

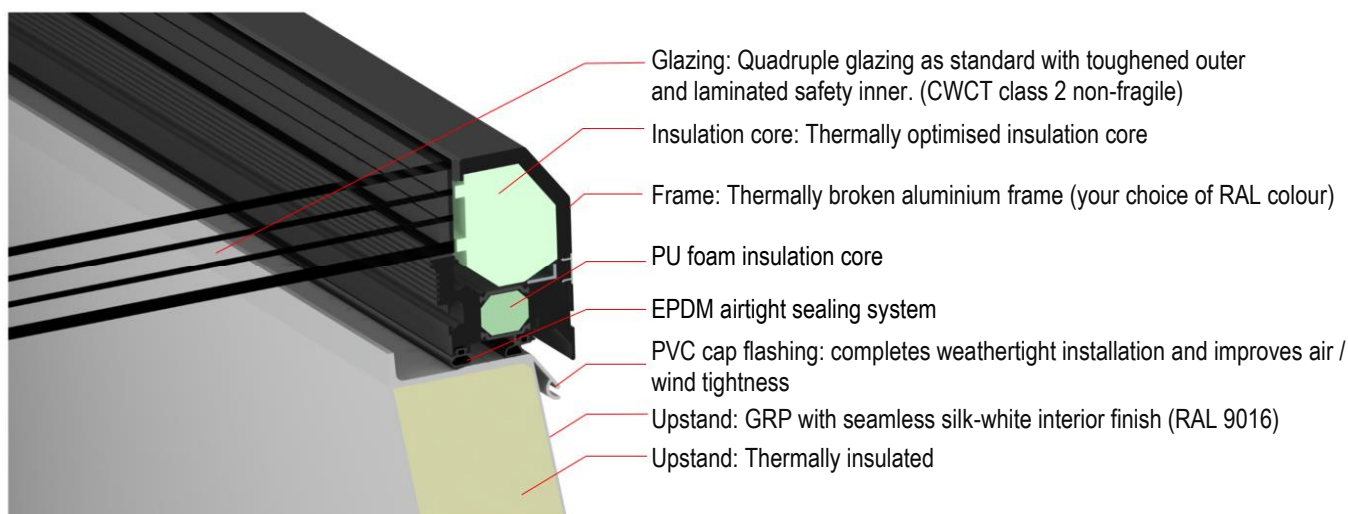

## Installation suitability.

Suitable for roofs from 0° up to a 5° pitch with upstand version: 500mm with 5° inclination

Suitable for roofs from 6° up to 25° pitch with upstand version: 500mm

## Dimensions.

Available structural roof opening sizes (mm)	Clear internal opening size (mm)
800 x 800	620 x 620
900 x 900	720 x 720
900 x 1200	720 x 1020
1000 x 1000	820 x 820
1000 x 1500	820 x 1320
1000 x 2000	820 x 1820
1200 x 1200	1020 x 1020
1200 x 1500	820 x 1320
1500 x 1500	1320 x 1320
1800 x 1800	1620 x 1620

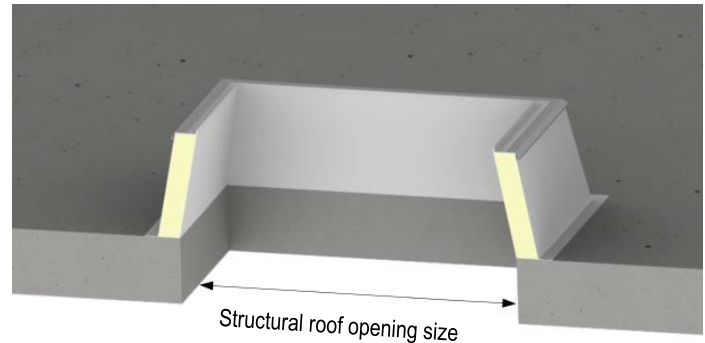

## Weights.

Structural roof opening size (mm)	Quadruple glazed	
	500mm upstand	500mm upstand – 5°
800 x 800	c. 74 kg	c. 79 kg
900 x 900	c. 87 kg	c. 92 kg
900 x 1200	c. 108 kg	c. 114 kg
1000 x 1000	c. 101 kg	c. 107 kg
1000 x 1500	c. 139 kg	c. 146 kg
1000 x 2000	c. 176 kg	c. 184 kg
1200 x 1200	c. 122 kg	c. 129 kg
1200 x 1500	c. 146 kg	c. 154 kg
1500 x 1500	c. 170 kg	c. 178 kg
1800 x 1800	c. 255 kg	c. 264 kg

## Upper part - framework.

The aluminium framework is coated in any single RAL colour as standard. Optionally dual powder coating is available if different internal and external finishes are preferred (note: longer delivery times and surcharge applicable)



## Upper part - glazing.

The LAMILUX Glass Skylight FE Passivhaus offers quadruple glazing as standard to fulfil the Passive House efficiency class: pH.C. Further glazing options are available. Please call us to discuss specific project specification requirements if they are not included in the below table.

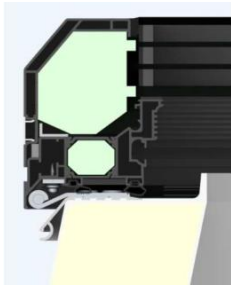

Type	Glass outside (Toughened)	Spacer	Glass centre panes	Spacer	Glass inside (Laminated)	Light Transmission	Total energy transmittance	Sound insulation value $R_{w,p}$	Ug-Value ( $W/m^2k$ )
Quadruple glazed clear – standard	6mm	14	2 x 3mm (13mm spacer)	13	8.8mm	66%	0.49	C. 39dB	0.56
Quadruple glazed – 60/30 solar control coating	6mm	14	2 x 3mm (13mm spacer)	13	8.8mm	50%	0.28	C. 39dB	0.56
Quadruple glazed – 50/25 solar control coating	6mm	14	2 x 3mm (13mm spacer)	13	8.8mm	41%	0.23	C. 39dB	0.56
Quadruple glazed – 70/37 solar control coating	6mm	14	2 x 3mm (13mm spacer)	13	8.8mm	57%	0.32	C. 39dB	0.56

The specified thicknesses of the panes and spaces between panes represent the standard configuration and may vary. The specified technical values are determined in accordance with the applicable regulations and standards on reference test specimens and may also vary slightly in individual cases. The data can deviate by up to 5% from the mentioned values.

## Upstand options.

Upstand is delivered pre-assembled to the upper part for quick and easy site installation with PVC cap flashing included. Standard upstand available in a choice of 500mm high / 500mm high with 5° inclination.

**GRP upstand 500mm high** - Suitable for roofs from 6° up to 25° pitch

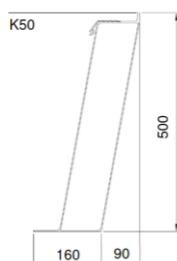

**GRP upstand 500mm high with 5° inclination** - Suitable for roofs from 0° up to 5° pitch

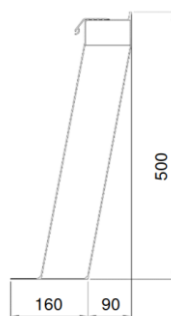

## Ventilation details.

**Chain drive (concealed within covering panel)**



Chain drive with covering panel

230V Hub 250-500mm  
24V Hub 300-750mm

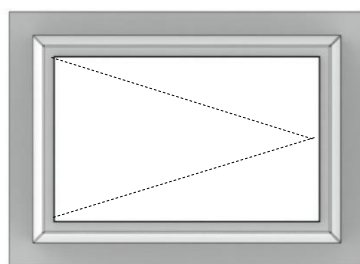

Hinged as standard on the short side

## Shading options.

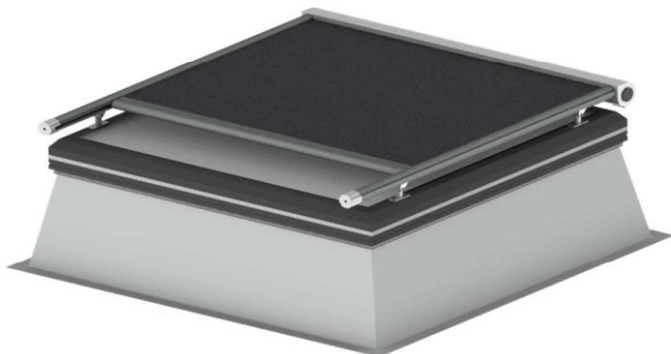

### External shading - fabric blind

- 230V motor operation (switch not included).
- Wind Load to Class 3 according to EN 13561 (38-48 km/h)
- For installation inclination <math><14^\circ</math> risk of water ponding
- Warning: Leave blind retracted and do not use in snowy / frosty conditions

### Standard Frame Colours:

Ral 9016 – Traffic White	5233 – Cream White*
Ral 9006 – White Aluminium	5229 – Havana Brown*
Ral 8019 – Grey Brown	5215 – Stone Grey Metallic*
	5204 - Anthracite-metallic*

\*Not Ral referenced – manufacturers own colour reference



### External shading – aluminium roller blind

- 230V tubular motor operation
- Max permissible wind speed (extended): 80 km/h (= 22 m/s)
- Warning: Leave blind retracted and do not use in snowy / frosty conditions
- Not available for 1800x1800mm roof opening size version

### Standard Frame and Roller Box Colours:

Ral 9006 – White Aluminium
Ral 8019 – Grey Brown
DB 703 – Iron Mica Grey

### Standard slat colours: (only available in the 3 combinations listed below)

1. RAL 7035 – Light Grey (inside) and DB 703 – Iron Mica Grey (outside)
2. RAL 7035 – Light Grey (inside) and Ral 8019 – Grey Brown (outside)
3. RAL 9016 – Traffic White (inside) and Ral 9016 – Traffic White (outside)

## Performance.

For full product performance specification available on request.

- CE marked quality according to EN 14351.
- Certified to Passive House efficiency class: C
- Comprehensive Environmental Product Declaration (EPD) according to EN 15804, EN ISO 14040 and EN ISO 14044.
- Achieves BROOF(t4) classification to EN 13501-5
- Life Cycle Assessment (LCA) to EN 15804.
- Air permeability to Class 4 according to BS EN 1026.
- Water tightness to Class 4 according to BS EN 12208.
- Wind Load to Class C5, EN 12211.
- CWCT Class 2 Non-fragile
- Thermally broken: 12.6° isothermal line remains within the structure

## Delivery, packing and storage.

All deliveries, unless otherwise agreed in writing, are by road transport and subject to our standard delivery terms, which are available within the document: 'Company overview and standard delivery and installation terms.' Off-loading is the responsibility of the buyer. Details of packing and safe storage are also included in this document.

## Interface and fitting.

Installation service, available on request. Subject to our standard installation terms, which are available within the document: 'Company overview and standard delivery and installation terms.' Installation guide available, please contact LAMILUX UK.

Flat roofing membrane or roof covering can be conveniently terminated by others under the drip detail at the top of the upstand to complete the weathertight assembly.

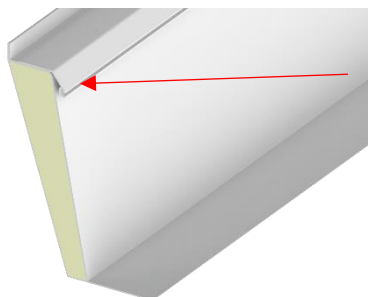

Please call to discuss contract/site specific install requirements.